



MAX5058 Evaluation Kit

Evaluates: MAX5051/MAX5058

General Description

The MAX5058 evaluation kit (EV kit) is a fully assembled and tested circuit board that contains a high-efficiency, 50W, isolated, synchronously rectified forward converter in the industry-standard 1/8th brick pinout. The circuit is configured for a +3.3V output voltage and provides up to 15A of output current. The circuit can be powered from either a +36V to +72V or -36V to -72V DC source in applications such as telecom/datacom (48V modules), industrial environments, or in automotive 42V power systems.

Using a clamped two-transistor power topology on the primary side and synchronous rectifiers on the secondary side achieves high efficiency up to 91% and is achieved at 9A. The efficiency improvement on the secondary side is achieved through synchronous rectification using the MAX5058 secondary-side synchronous rectifier driver and feedback generator controller IC, which drives two n-channel MOSFETs. Additionally, the recovery of stored leakage and magnetizing inductance energy at the primary side contributes to the overall efficiency improvement. The primary side uses a MAX5051 parallelable, clamped, two-switch power-supply controller IC. Galvanic isolation up to 500V is achieved with an optocoupler, pulse-signal transformer, and planar surface-mount power transformer.

Operation at 250kHz allows the use of small magnetics and output capacitors. The EV kit provides cycle-by-cycle current-limit protection. Additional steady-state fault protection is provided by an integrating fault protection that reduces average dissipated power during continuous short-circuit conditions. The MAX5051 also has a programmable undervoltage lockout (UVLO). Multiple MAX5058 EV kits can be paralleled for increased power capability when high output current is required. Margin-up/down capability enables an increase or decrease in the output voltage. The EV kit demonstrates the MAX5058 look-ahead signal capability, on-board error amplifier, and reference voltage source. Remote-load voltage sensing allows accurate voltage regulation at the load.

Warning: The MAX5058 EV kit is designed to operate with high voltages. Dangerous voltages are present on this EV kit and on equipment connected to it. Users who power up this EV kit or power the sources connected to it must be careful to follow safety procedures appropriate to working with high-voltage electrical equipment.

Under severe fault or failure conditions, this EV kit may dissipate large amounts of power, which could result in the mechanical ejection of a component or of component debris at high velocity. Operate this kit with care to avoid possible personal injury.

The user must supply an additional 100 μ F bulk storage capacitor between the EV kit's +VIN and -VIN input terminals before powering up or the MAX5058 EV kit may be damaged.

Features

- ◆ 50W High-Efficiency, Isolated Forward Converter
- ◆ Synchronously Rectified
- ◆ Differential Load-Share Bus for Paralleling
- ◆ $\pm 36V$ to $\pm 72V$ Input Range
- ◆ +3.3V Output at 15A
- ◆ VOUT Regulation Better than $\pm 0.5\%$ Over Line and Load
- ◆ 89% Efficiency at 48V and 9A
- ◆ Cycle-by-Cycle Current-Limit Protection
- ◆ Programmable Integrating Fault Protection
- ◆ 1/8th Brick Module Pinout
- ◆ 250kHz Switching Frequency
- ◆ Soft-Start
- ◆ Margin-Up/Down Capability
- ◆ Remote-Load Voltage Sensing
- ◆ On-Board Error Amplifier and Reference Voltage Source
- ◆ Fully Assembled and Tested

Ordering Information

PART	TEMP RANGE	IC PACKAGE
MAX5058EVKIT	0°C to +50°C*	28 TSSOP-EP

*With 100LFM airflow.

MAX5058 Evaluation Kit

Evaluates: MAX5051/MAX5058

Component List

DESIGNATION	QTY	DESCRIPTION
C1	1	100pF ±2%, 50V C0G ceramic capacitor (0603) Murata GRM1885C1H101G
C2	1	390pF ±5%, 50V C0G ceramic capacitor (0603) Murata GRM1885C1H391J
C3	1	4.7µF ±10%, 10V X5R ceramic capacitor (0805) TDK C2012X5R1A475K
C4	1	4.7µF ±10%, 6.3V X5R ceramic capacitor (0805) TDK C2012X5R0J475K
C5, C40	2	4700pF ±10%, 50V X7R ceramic capacitors (0603) Murata GRM188R71H472K
C6	1	0.1µF ±10%, 250V X7R ceramic capacitor (1206) TDK C3216X7R2E104K
C7	1	0.22µF ±10%, 10V X7R ceramic capacitor (0603) TDK C1608X7R1C224K
C8	1	4.7µF ±10%, 16V X7R ceramic capacitor (1206) TDK C3216X7R1C475K
C9, C29	2	1µF ±10%, 16V X7R ceramic capacitors (0805) Taiyo Yuden EMK212BJ105KG
C10, C11	2	0.47µF ±10%, 100V X7R ceramic capacitors (1206) TDK C3216X7R2A474K
C12	1	1µF ±20%, 100V X7R ceramic capacitor (1210) TDK C3225X7R2A105M
C13, C14, C15	3	270µF, 4V aluminum organic capacitors (X) Kemet A700X277M004ATE015
C16	1	3.3µF ±10%, 6.3V X5R ceramic capacitor (0805) Taiyo Yuden JMK212BJ335KG

DESIGNATION	QTY	DESCRIPTION
C17	1	0.33µF ±10%, 10V X5R ceramic capacitor (0603) TDK C1608X5R1A334K
C18, C24	2	1000pF ±5%, 50V C0G ceramic capacitors (0603) TDK C1608C0G1H102J
C19, C30, C33	3	1µF ±10%, 10V X5R ceramic capacitors (0603) TDK C1608X5R1A105K
C20, C37	2	220pF ±10%, 50V C0G ceramic capacitors (0603) TDK C1608C0G1H221K
C21	1	4.7µF, 80V electrolytic capacitor (6.3mm x 5.8mm) Cornell-Dubilier AFK475M80D16B
C22	1	2200pF ±10%, 2kV X7R ceramic capacitor (1812) TDK C4532X7R3D222K
C23	1	1000pF, 250V X7R ceramic capacitor (0603) Murata GRM188R72E102K
C25	1	0.047µF ±10%, 100V X7R ceramic capacitor (0805) TDK C2012X7R2A473K
C26, C31	2	0.1µF ±10%, 16V X7R ceramic capacitors (0603) TDK C1608X7R1C104K
C27	1	0.15µF ±10%, 16V X7R ceramic capacitor (0603) Taiyo Yuden EMK107BJ154KA
C28	1	0.047µF ±10%, 25V X7R ceramic capacitor (0603) TDK C1608X7R1E473K
C32	1	1µF ±10%, 25V X7R ceramic capacitor (0805) TDK C2012X7R1E105K

MAX5058 Evaluation Kit

Component List (continued)

DESIGNATION	QTY	DESCRIPTION
C34	1	330pF $\pm 5\%$, 250V C0G ceramic capacitor (0603) TDK C1608C0G2E331J
C35, C36	2	1 μ F $\pm 10\%$, 50V X7R ceramic capacitors (1206) TDK C3216X7R1H105K
C38	1	0.068 μ F $\pm 10\%$, 50V X7R ceramic capacitor (0603) TDK C1608X7R1H683K
C39	0	Not installed, ceramic capacitor (0603)
D1	1	150mA, 100V Schottky diode (SOD-123) Vishay BAT46W
D2, D3	2	1A, 100V Schottky diodes (SMA) Diodes Incorporated B1100
D4	1	3A, 20V Schottky diode (SMA) Diodes Incorporated B320A
D5, D6, D8, D10, D11	5	250mA, 100V fast-switching diodes (SOD-323) Diodes Incorporated 1N4448HWS
D7, D9	2	100mA, 30V Schottky diodes (SOD-523) Central Semiconductor CMOSH-3
L1	1	2.4 μ H, 20A inductor Payton 50661 or Coilcraft A9860-B* or Pulse Engineering PA1494-242*
N1, N2	2	100V, 7.3A n-channel MOSFETs (SO-8) International Rectifier IRF7495
N3, N4	2	30V, 20A n-channel MOSFETs (SO-8) International Rectifier IRF7832
N5	1	170mA, 100V n-channel MOSFET (SOT23) Fairchild BSS123
R1, R2	2	19.1k Ω $\pm 0.1\%$, 25ppm resistors (0603) Panasonic ERA3EEB1912V
R3	1	2.2k Ω $\pm 5\%$ resistor (0603)

DESIGNATION	QTY	DESCRIPTION
R4	1	1M Ω $\pm 1\%$ resistor (0603)
R5	1	38.3k Ω $\pm 1\%$ resistor (0603)
R6	1	1M Ω $\pm 1\%$ resistor (0805)
R7, R35	2	0 Ω $\pm 5\%$ resistors (0603)
R8, R9	2	8.2 Ω $\pm 5\%$ resistors (0603)
R10	1	20 Ω $\pm 5\%$ resistor (1206)
R11	1	360 Ω $\pm 5\%$ resistor (0603)
R12	1	34.8k Ω $\pm 0.5\%$, 100ppm resistor (0603) Panasonic ERA3EKD3482V
R13	1	47 Ω $\pm 5\%$ resistor (1206)
R14	1	270 Ω $\pm 5\%$ resistor (0603)
R15	1	31.6k Ω $\pm 1\%$ resistor (0603)
R16	1	10.5k Ω $\pm 1\%$ resistor (0603)
R17	1	0.027 Ω $\pm 1\%$ 0.5W resistor (1206) IRC LRF-1206-01-R027-F
R18	1	4.7 Ω $\pm 5\%$ resistor (1206)
R19	1	475 Ω $\pm 1\%$ resistor (0805)
R20, R36	2	0.004 Ω $\pm 1\%$ resistors (1206) IRC LRF-1206-01-R004-F
R21	1	24.9k Ω $\pm 1\%$ resistor (0805)
R22	1	15k Ω $\pm 5\%$ resistor (1206)
R23, R24	2	10 Ω $\pm 5\%$ resistors (0805)
R25	1	47.5k Ω $\pm 1\%$ resistor (0603)
R26	1	0.002 Ω $\pm 5\%$ resistor (2512) IRC LRF-2512-01-R002-J
R27	1	10 Ω $\pm 5\%$ resistor (0603)
R28	1	301 Ω $\pm 1\%$ resistor (0805)
R29	1	1 Ω $\pm 5\%$ resistor (0603)
R30	1	2k Ω $\pm 1\%$ resistor (0603)
R31	1	220 Ω $\pm 5\%$ resistor (0603)
R32	1	698k Ω $\pm 1\%$ resistor (0805) Panasonic ERJA6ENF6983V
R33	1	604k Ω $\pm 1\%$ resistor (0805) Panasonic ERJ6ENF6043V
R34	1	220k Ω $\pm 5\%$ resistor (0603)
R37, R38	2	10 Ω $\pm 5\%$ resistors (0603)
R39	1	2k Ω $\pm 5\%$ resistor (1206)
R40	1	32.4k Ω $\pm 1\%$ resistor (0603)

Evaluates: MAX5051/MAX5058

MAX5058 Evaluation Kit

Component List (continued)

DESIGNATION	QTY	DESCRIPTION
T1	1	Planar transformer Pulse Engineering PA0370
T2	1	Drive transformer Pulse Engineering PE-68386
U1	1	Parallelable, clamped, two-switch power-supply controller MAXIM MAX5051AUI (28 TSSOP-EP)
U2	1	High-voltage optocoupler (Ultra-small flat-lead) CEL/NEC PS2913-1-M

DESIGNATION	QTY	DESCRIPTION
U3	1	Secondary-side synchronous rectifier driver and feedback generator controller MAXIM MAX5058EUI (28-pin TSSOP-EP)
+VIN, -VIN, ON/OFF	3	0.040in PC pins
VOUT, SGND	2	0.062in PC pins
None	1	MAX5058 PC board

*Modifications to the PC board traces are required to evaluate this component.

Component Suppliers

SUPPLIER	PHONE	FAX	WEBSITE
CEL/NEC; California Eastern Laboratories	800-997-5227	408-588-2213	www.cel.com
Coilcraft	847-639-6400	847-639-1469	www.coilcraft.com
Cornell Dubilier	508-996-8564	508-336-3830	www.cornell-dubilier.com
Diodes Inc	805-446-4800	805-446-4850	www.diodes.com
Fairchild	888-522-5372	—	www.fairchildsemi.com
International Rectifier	310-322-3331	310-726-8721	www.irf.com
IRC	361-992-7900	361-992-3377	www.irctt.com
Kemet	864-963-6300	864-963-6322	www.kemet.com
Murata	770-436-1300	770-436-3030	www.murata.com
Panasonic	714-373-7366	714-737-7323	www.panasonic.com
Payton Planar Magnetics Ltd.	561-969-9585	561-989-9587	www.paytongroup.com
Pulse Engineering	858-674-8100	858-674-8262	www.pulseeng.com
Taiyo Yuden	800-348-2496	847-925-0899	www.t-yuden.com
TDK	847-803-6100	847-390-4405	www.component.tdk.com
Vishay	—	—	www.vishay.com

Note: Indicate that you are using the MAX5058 when contacting these component suppliers.

Quick Start

Required Equipment

- $\pm 36V$ to $\pm 72V$ power supply capable of providing up to 3A
- Voltmeter
- A fan to provide at least 100LFM airflow for extended operation at 15A

- 100 μ F, 100V bulk storage capacitor to be connected to the input terminals of the EV kit

The MAX5058 EV kit is fully assembled and tested. Follow these steps to verify board operation. **Do not turn on the power supply until all connections are completed.**

MAX5058 Evaluation Kit

No Load Output

- 1) Connect a voltmeter to the VOUT and SGND pins to measure the output voltage.
- 2) Connect the positive terminal of a 36V to 72V power supply to the +VIN terminal. Connect the power supply's ground to the -VIN terminal.
- 3) Turn on the power supply above 36V and verify that the voltmeter reads +3.3V.

Note: For improved voltage regulation at the load, connect a 22-gauge twisted-pair cable from the VS+ and VS- terminals of the MAX5058 EV kit, to the load positive and ground terminals, respectively. Connect the VOUT and SGND terminals to the load with power cables sized to carry the full load current, up to 15A.

Detailed Description

The MAX5058 EV kit is a 50W, isolated, synchronously rectified forward converter that provides +3.3V at up to 15A output. The circuit can be powered from a $\pm 36V$ to $\pm 72V$ DC source. **The user must supply an additional 100 μ F bulk storage capacitor between the +VIN and -VIN input terminals before powering up or the MAX5058 EV kit may be damaged.** This capacitor should be rated for 100V and be able to carry 1.5A of ripple current. Lower ripple-current-rated capacitors should be acceptable for short-term operation.

The 50W forward converter achieves high efficiency by using a clamped two-transistor power topology at the primary input and synchronous rectifiers on the secondary output side. A MAX5051 parallelable, clamped, two-switch, power-supply controller IC switches the two primary-side, 100V-rated transistors, N1 and N2. A MAX5058 secondary-side synchronous rectifier driver and feedback generator controller IC drives two surface-mount SO-8 n-channel 30V-rated MOSFETs configured as synchronous rectifiers on the secondary side. MOSFET N3 provides secondary-side rectification and MOSFET N4 synchronously rectifies the current flowing through freewheeling diode D4.

The PC board footprint is minimized by using surface-mount SO-8 n-channel MOSFETs on the primary side. Cycle-by-cycle current limiting protects the converter against short circuits at the output. For a continuous short circuit at the output, the MAX5051's fault integration feature provides hiccup fault protection, thus greatly minimizing excessive temperature rise. Current-sense resistor R17 senses the current through the primary of transformer T1 and both primary-side transistors N1 and N2 are turned off when the trip level of 154mV (typ) is reached. The programmable integrating fault protection allows transient overload conditions to be ignored and is configured by resistor R4 and capacitor C7.

The planar surface-mount transformer features a bias winding that, along with diode D5, current-limiting resistor R18, and reservoir capacitor C21, powers the MAX5051 once the input voltage is stable. Upon initial input voltage application, bootstrap resistor R22 and capacitor C21 enable the MAX5051 to startup within approximately 70ms. No reset windings are required on the transformer with a clamped two-transistor power topology, simplifying transformer design and maximizing the available copper window in the transformer. When both external primary-side transistors turn off, Schottky diodes D2 and D3 recover the magnetic energy stored in the core and feed it back to the input supply. The transformer provides galvanic isolation up to 500V.

On the transformer's secondary side, the MAX5058 built-in error amplifier, reference voltage source, and feedback resistors R1 and R2 provide voltage feedback to the primary side through optocoupler U2.

Resistor R12 sets the reference voltage for the MAX5058 to 1.657V. Margin-up/down capability enables an increase or decrease in the output voltage by 5% and is configurable by replacing resistors R32 and R33. On the primary side, the MAX5051 receives the voltage-feedback signal from biasing resistor R3 and compensation resistor/capacitor networks R11/C17 and C24 connected to optocoupler U2.

Pulse transformer T2 provides a galvanically isolated signal to the MAX5058 secondary-side synchronous rectifier driver circuit from the MAX5051 PWM primary-side signal. This look-ahead signal avoids large current spikes resulting from a shorted transformer secondary when the freewheeling synchronous rectifier (N4) and primary-side MOSFETs concurrently conduct.

The MAX5051 controller switches at a 250kHz frequency set by resistor R21 and capacitor C1. The duty cycle is varied to control energy transfer to the output. The maximum duty cycle is 50% for the EV kit's synchronously rectified forward converter design and is limited by the MAX5051.

The MAX5058 EV kit features output-voltage soft-start, thus eliminating any output-voltage overshoots. Soft-start allows the output voltage to slowly ramp up in a controlled manner within approximately 3ms. Capacitor C5 sets the soft-start time. The brownout UVLO threshold voltage is set by resistors R5 and R6. This prevents the power supply from operating below the minimum input supply voltage.

Multiple MAX5058 EV kits can be easily paralleled for increased power capabilities when high output current is required. Parallel-connected resistors R20 and R36 facilitate current sharing when multiple MAX5058 EV

MAX5058 Evaluation Kit

kits are connected in parallel. Test points TP7 (SFP) and TP8 (SFN) provide access to the MAX5058 IC's simple 2-wire, differential current-share bus (contact factory for more details).

Remote-load voltage sensing is provided by interfacing points VS+ and VS-, which use the MAX5058 built-in remote-sense amplifier. A 22-gauge twisted-pair cable should be used for connecting the remote-load voltage-sensing terminals. This will provide accurate voltage regulation at the load when long leads are used to provide power from the EV kit to the load. If the load is located next to the MAX5058 EV kit, connect VS- to SGND and connect VS+ to the VOUT pin.

The output voltage can be margined up or down (increased or decreased) 5% by applying a logic-high signal at the TPMU (MRGU) test point and TPMD (MRGD) test point, respectively. Resistors R32 and R33 set the margin up and down at 5%, respectively.

A secondary-side thermal overtemperature warning is provided by the MAX5058 through an open-drain thermal flag signal available at test point TP2. Use test point TP3 (SGND) as a secondary-side ground path for TP2.

The 4-layer PC board layout and component placement has been designed to have an industry-standard 1/8th brick pinout. The actual PC board dimensions of the power-supply board are somewhat larger than that of 1/8th brick power supplies (58.42mm x 41.65mm). Both outer layers of the PC board are 2oz copper for increased current-carrying capability.

Evaluating Other Output Voltages, Current Limits, Soft-Starts, UVLOs, and Output-Voltage Margining Up/Down

VOUT Output Voltage

The MAX5058 EV kit's output (VOUT) is configured to +3.3V by feedback resistors R1, R2, and the MAX5058 reference voltage set by resistors R12 and R32 (1.657V as configured). To generate output voltages other than +3.3V (from +2.5V to +3.5V, limited by the output capacitor voltage rating), select different voltage-divider resistors (R1, R2) and consult the MAX5058 data sheet's *Calculation Procedure for Output-Voltage-Setting Resistors and Margining* section. Resistor R1 is typically chosen to be less than 25kΩ. Using the desired output voltage, resistor R2 is then found by the following equation:

$$R2 = \frac{V_{\text{REF}}}{V_{\text{OUT}} - V_{\text{REF}}} \times R1$$

where $V_{\text{REF}} = 1.675\text{V}$ (as configured).

Resistors R1 and R2 preferably should have 0.1% tolerance. Additionally, U2 and resistor R19 limit the minimum output voltage (VOUT) to +2.5V. The maximum output current should be limited to less than 15A. Refer to the MAX5058 data sheet's *Calculation Procedure for Output-Voltage-Setting Resistors and Margining* section for additional information.

For improved point-of-load voltage regulation, connect the VS+ and VS- terminals to the load's positive and negative input power terminals, respectively. A 22-gauge twisted-pair wire should be used for this dedicated connection. Connect the appropriately sized main power cables from the EV kit's VOUT and SGND pins.

Current Limiting

The MAX5058 EV kit features cycle-by-cycle current limiting of the transformer primary current. The MAX5051 controller turns off both external primary-side switching transistors (N1, N2) when the voltage at the CS pin of the MAX5051 reaches 154mV (typ). Current-sense resistor R17 ($R17 = 27\text{m}\Omega$) limits the peak primary current to approximately 5.7A ($154\text{mV}/0.027\Omega \approx 5.7\text{A}$). This limits short-circuit current on the secondary output (VOUT) to 20A with a 50mΩ short at the terminals (see Figure 7). To evaluate lower current limits, current-sense resistor R17 must be replaced with a different value surface-mount resistor (1206 size) as determined by the following equation:

$$R17 = \frac{V_{\text{SENSE}}}{((N_S/N_P) \times (1.2 \times I_{\text{OUTMAX}}))}$$

where $V_{\text{SENSE}} = 0.154\text{V}$, $N_S = 2$, $N_P = 8$, and I_{OUTMAX} = maximum DC output current (15A or less). Note that some fine tuning may be required when selecting the current-limit resistor. There are errors introduced as a result of the presence of the transformer, output inductor ripple current, and propagation delays.

Soft-Start

The MAX5051 controller limits the output voltage rate of rise with a soft-start feature. Capacitor C5 sets the ramp time to 91μs. To evaluate other soft-start ramp times replace capacitor C5 with another surface-mount capacitor (0603 size) as determined by the following equation:

$$C5 = \frac{(64\mu\text{A} \times \text{softstart_time})}{1.24\text{V}}$$

where softstart_time is the desired soft-start time in seconds. Consult the MAX5051 data sheet for additional information on the soft-start feature.

MAX5058 Evaluation Kit

Evaluates: MAX5051/MAX5058

Undervoltage Lockout (UVLO)

The MAX5058 EV kit features a UVLO circuit that prevents operation below the programmed input-supply startup voltage. Resistors R5 and R6 set the EV kit's input voltage brownout UVLO. To evaluate other input UVLO voltages, replace resistor R6 with another surface-mount resistor (0805 size). Using the desired startup voltage, resistor R6 is then found by the following equation:

$$R6 = \frac{(V_{INSTARTUP} - 1.24)}{1.24V} \times R5$$

where $V_{INSTARTUP}$ is the desired startup voltage at which the EV kit starts and resistor R5 is typically 38.3kΩ. Consult the MAX5051 data sheet for additional information on the UVLO feature.

VOUT Margining Up and Down

The MAX5058 EV kit features a margin-up/down capability to increase or decrease the output voltage by 5%. The percentage of margining is configurable by replacing resistors R32 and R33 on the secondary side. To increase the output voltage, apply a logic-high signal (2.4V up to 4V) at the TPMU (MRGU) test point to increase the output voltage or apply a logic-high signal (2.4V up to 4V) at the TPMD (MRGD) test point to decrease the output voltage. Refer to the MAX5058 data sheet for more information on the voltage-margining feature.

Synchronously Rectified Forward DC-DC Converter Waveforms

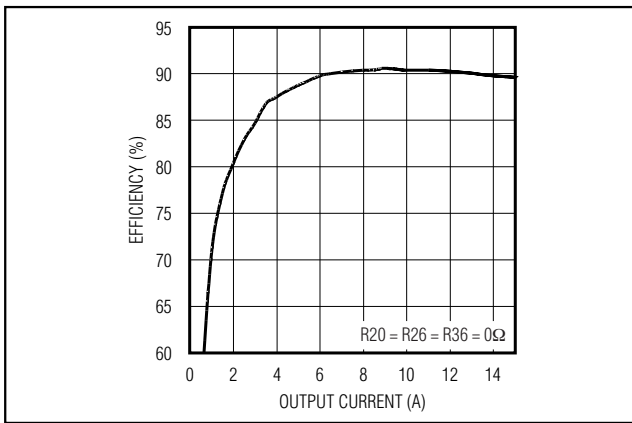

Figure 1. Efficiency vs. Output Current for Nominal (48V) Input Voltage at $T_A = +25^\circ\text{C}$

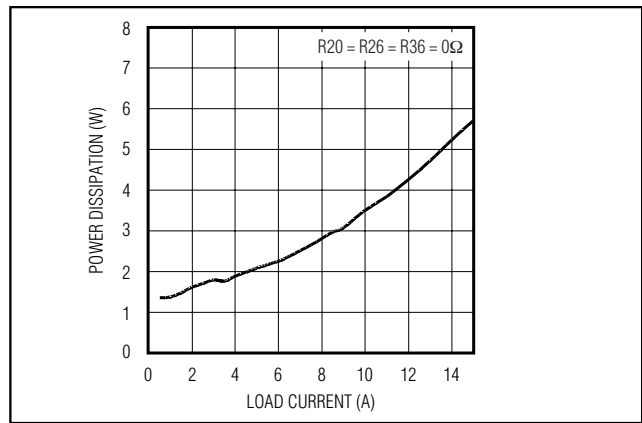

Figure 2. Power Dissipation vs. Load Current for Nominal (48V) Input Voltage at $T_A = +25^\circ\text{C}$

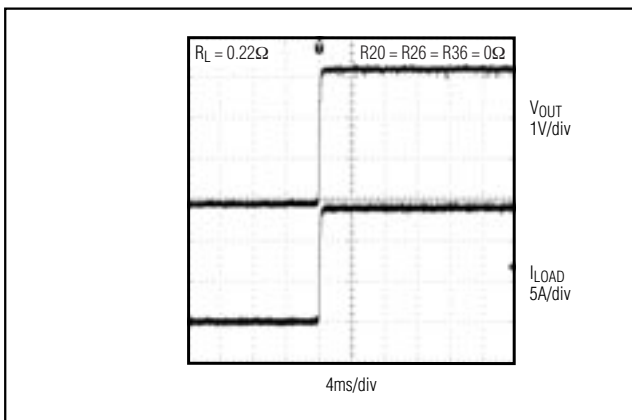

Figure 3. Turn-On Transient at Full Load (Resistive Load) (4ms/div)

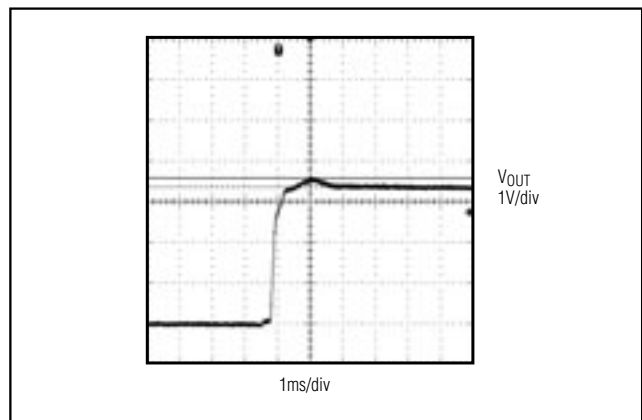

Figure 4. Turn-On Transient at Zero Load (4ms/div)

MAX5058 Evaluation Kit

Evaluates: MAX5051/MAX5058

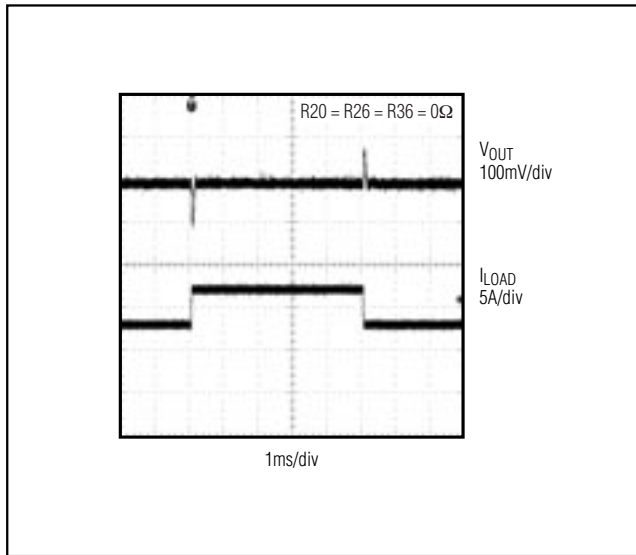

Figure 5. Output-Voltage Response to Step Change in Load Current (50%-75%-50% of $I_{OUT(MAX)}$; $di/dt = 5A/ms$) (7.5A-11.25A-7.5A)

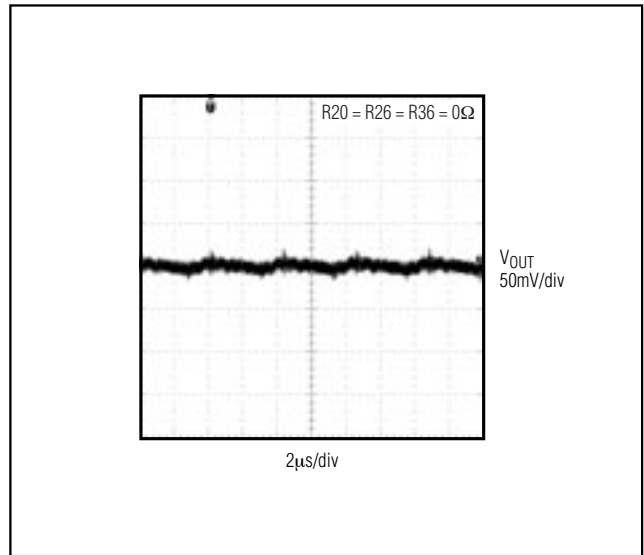

Figure 6. Output-Voltage Ripple at the Nominal Input Voltage and Rated Load Current (50mV/div)

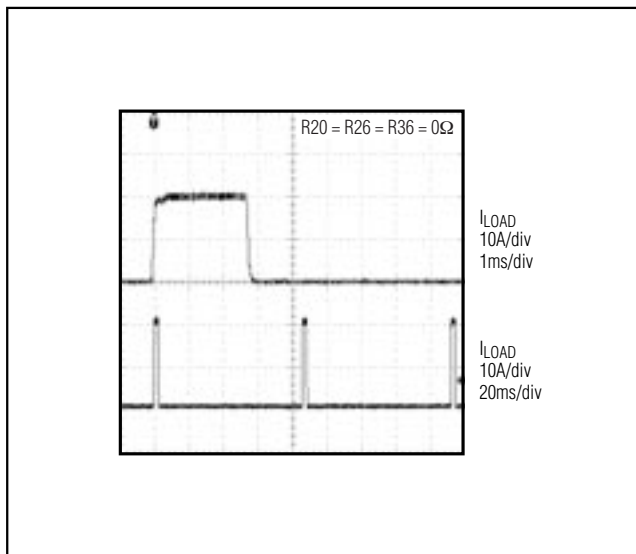

Figure 7. Load Current (15A/div) as a Function of Time when the Converter Attempts to Turn On into a 0.050Ω (Also Acting as the Current-Sense Resistor) Short Circuit

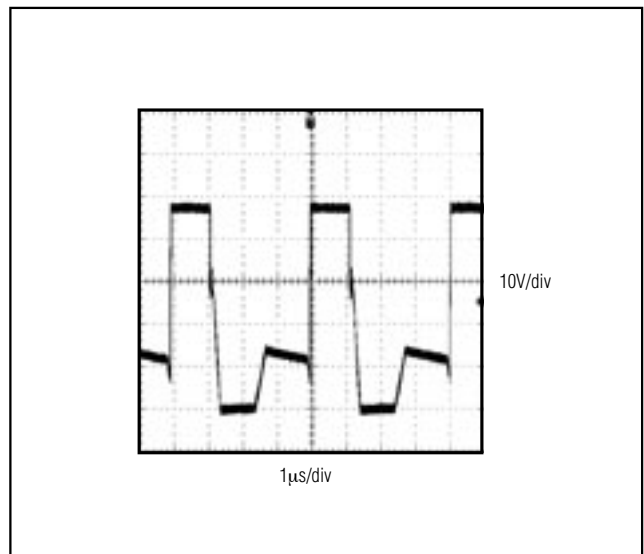

Figure 8. MOSFET N1 Source to Primary Ground (-VIN) Waveform

MAX5058 Evaluation Kit

Evaluates: MAX5051/MAX5058

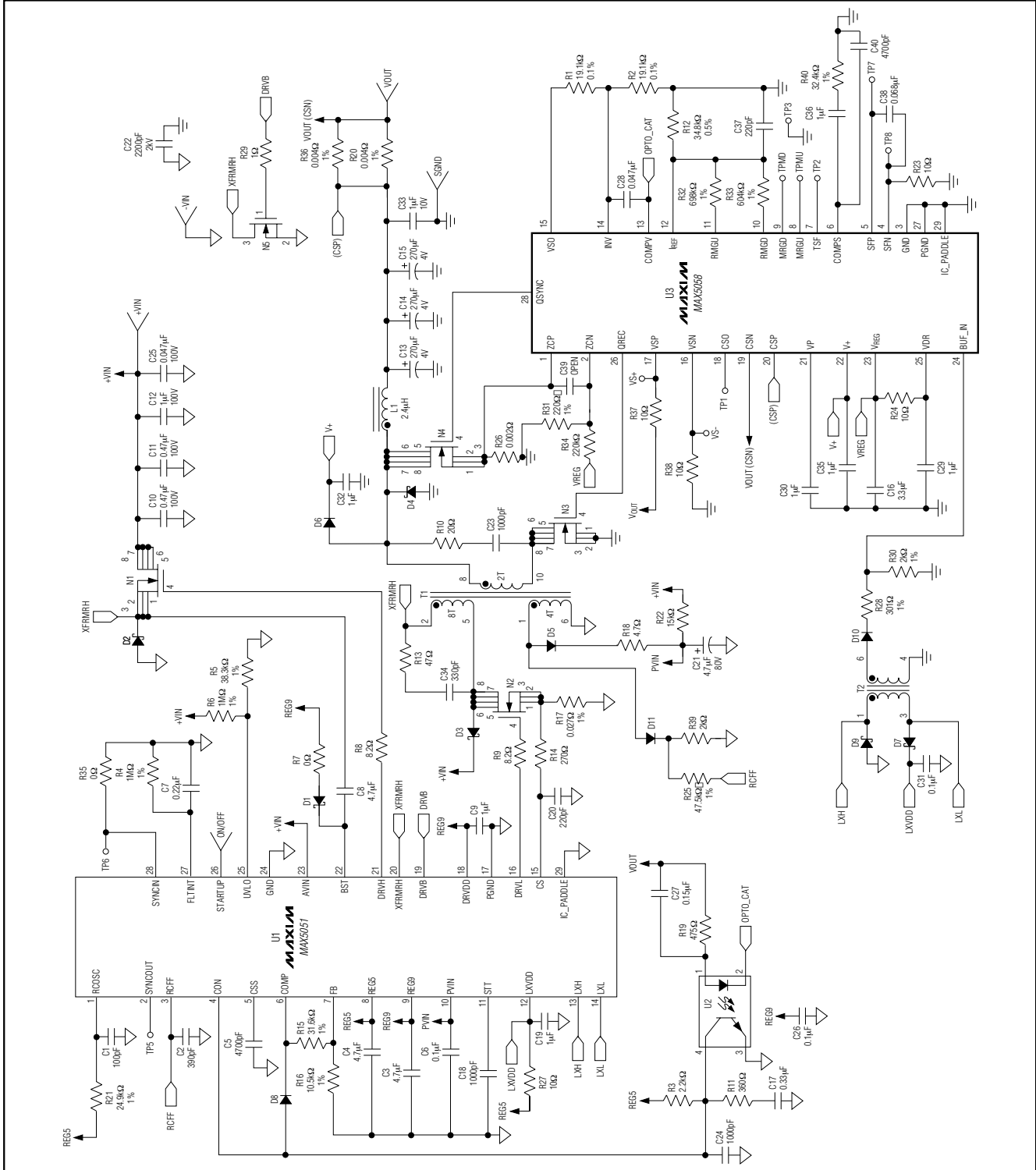

Figure 9. MAX5058 EV Kit Schematic

MAX5058 Evaluation Kit

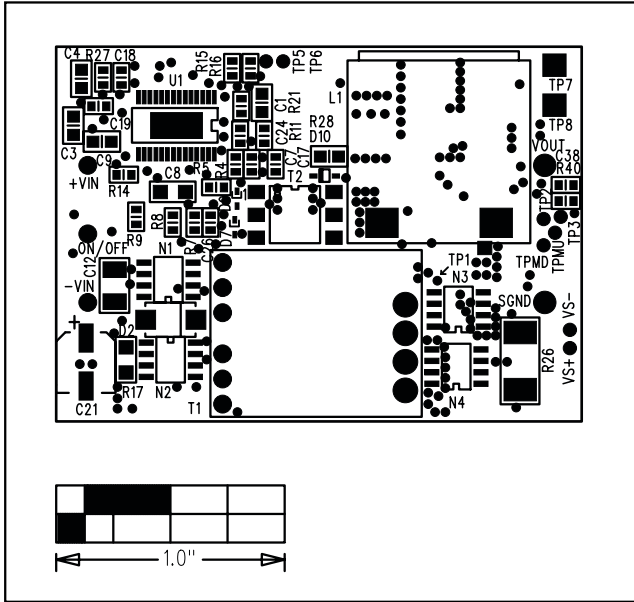

Figure 10. MAX5058 EV Kit Component Placement Guide—Component Side

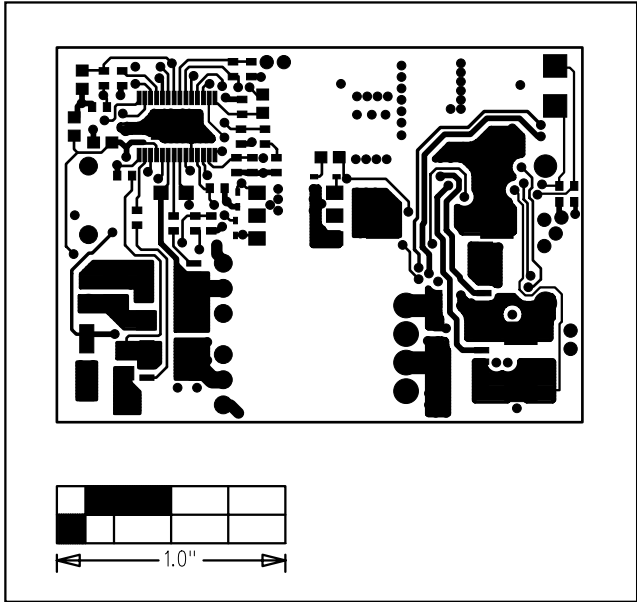

Figure 11. MAX5058 EV Kit PC Board Layout—Component Side

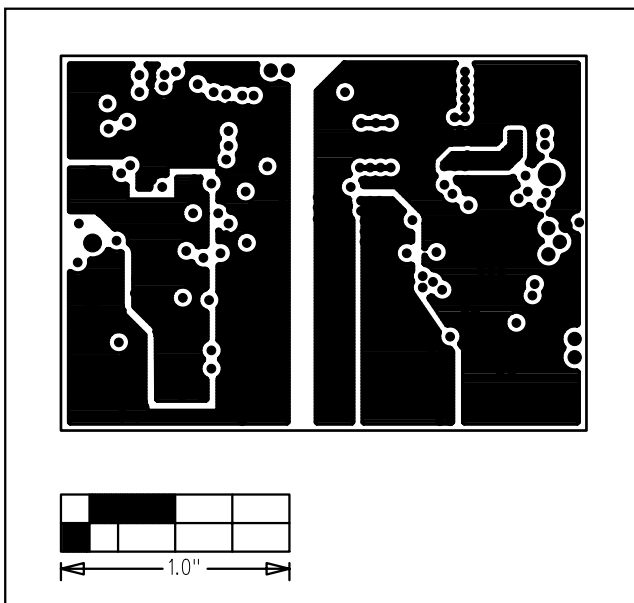

Figure 12. MAX5058 EV Kit PC Board Layout—Inner Layer, GND Plane

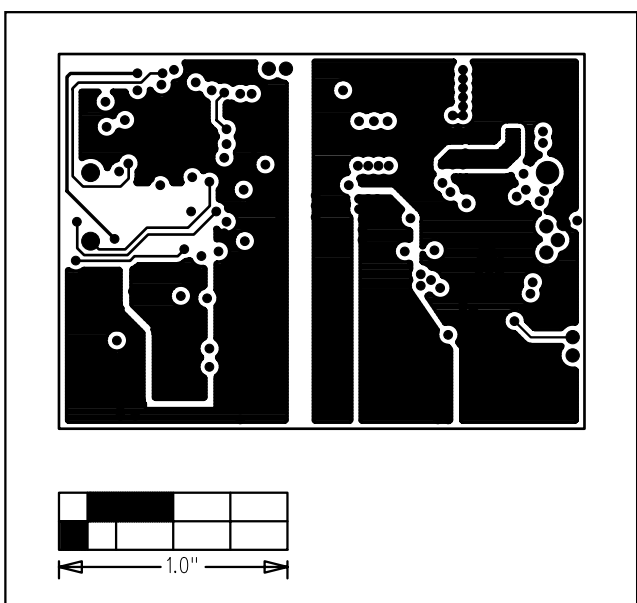

Figure 13. MAX5058 EV Kit PC Board Layout—Inner Layer, VCC Plane

MAX5058 Evaluation Kit

Evaluates: MAX5051/MAX5058

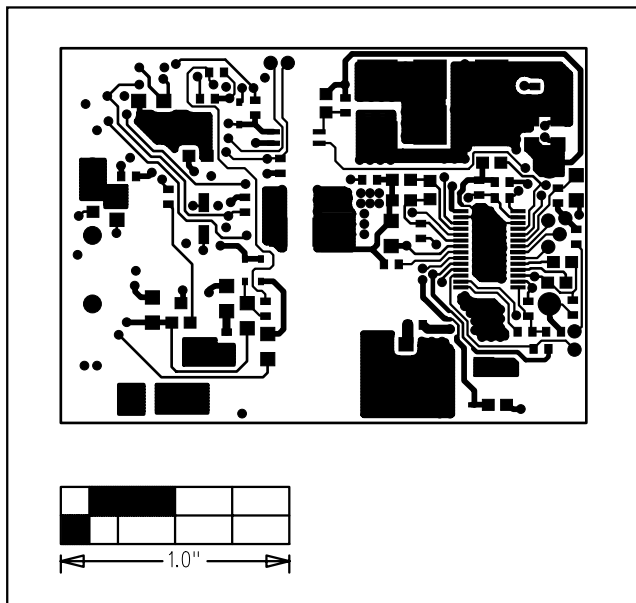

Figure 14. MAX5058 EV Kit PC Board Layout—Solder Side

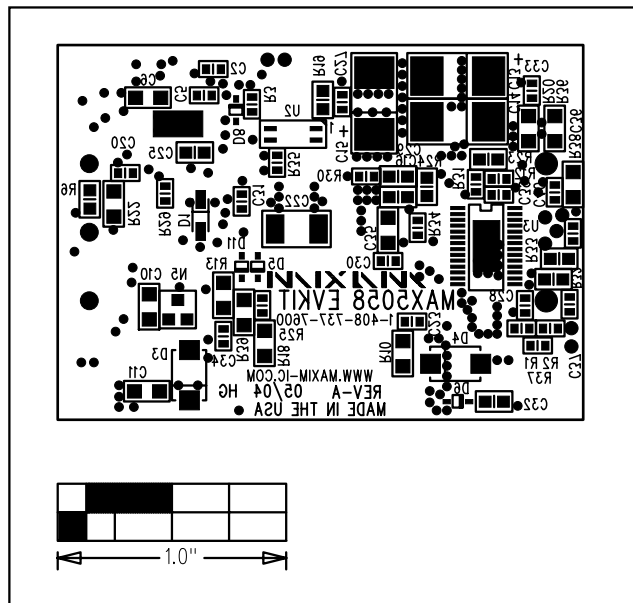

Figure 15. MAX5058 EV Kit Component Placement Guide—Solder Side

Maxim cannot assume responsibility for use of any circuitry other than circuitry entirely embodied in a Maxim product. No circuit patent licenses are implied. Maxim reserves the right to change the circuitry and specifications without notice at any time.

Maxim Integrated Products, 120 San Gabriel Drive, Sunnyvale, CA 94086 408-737-7600 _____ 11